

## Hydro Bond Engineering Ltd

### EExd and EExde Explosion Proof Connectors: Underwater Mateable HXD (Hydro Bond EExd / EExde)

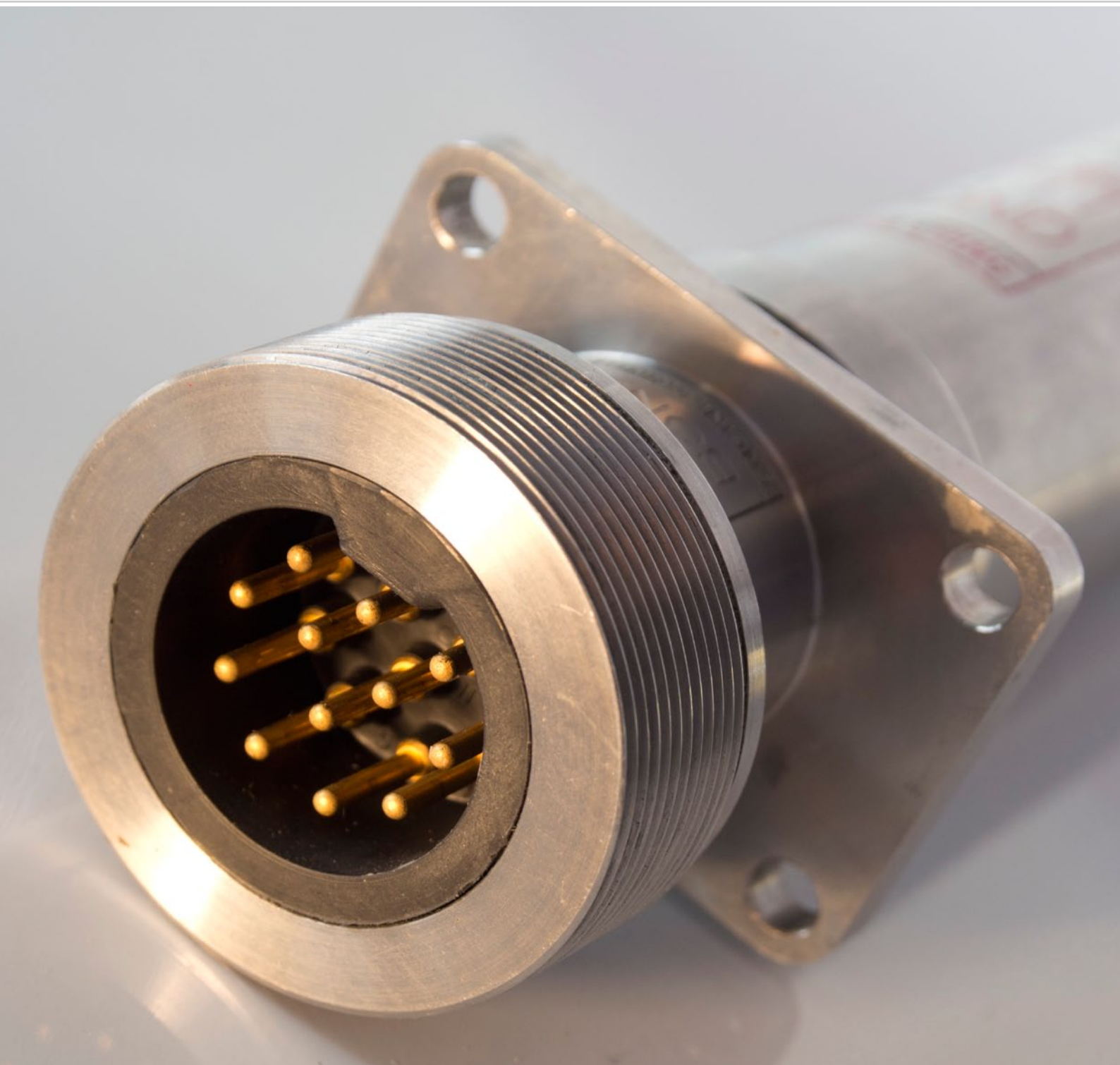

## EExd and EExde Explosion Proof Connectors

### Underwater Mateable HXD (Hydro Bond EExd / EExde)

Hydro Bond Engineering Ltd offer Underwater Mateable EExd and EExde Explosion Proof Connectors from its extensive, high integrity range of subsea connectors.

Our in house engineered and developed electrical technology is at the forefront of harsh environment requirements. Our products have been extensively tested both internally and externally and are field proven on major local, national and international projects.

Our Electrical Engineers and Technicians are fully trained and certified on our equipment by City & Guilds.

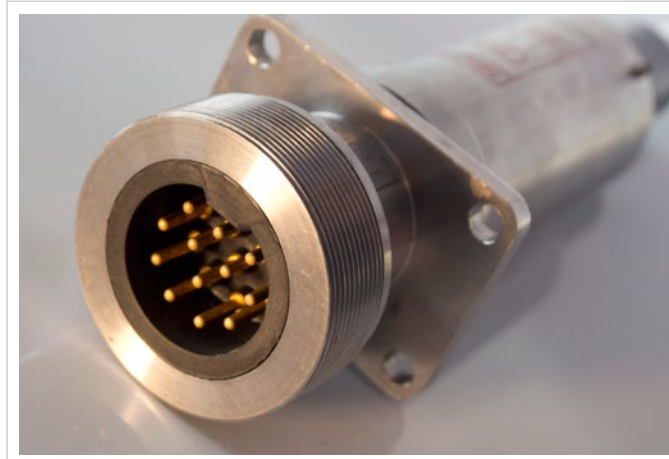

HXD: (Connector)

### Features

- Underwater Mateable
- Robust Design
- Neoprene moulded connector insert as standard with other materials available on request (subject to approval)
- Depth rated to 2,440 MSW (subject to cable gland and moulding option)
- Fully open face pressure sealed
- Metal Shell Construction
- Available in 5 shell sizes
- Bulkhead Mount and Panel Mount Designs available as standard
- Panel Mount and Bulkhead mount receptacles come with either solder buckets in the HXD3 or 0.75 metre conductor tails in the HXDe3/4 versions. Longer conductor tails available on request
- Mounting O – Ring face seals
- Pin Densities from 1 to 70 ways
- Voltage ratings up to 3,300 Volts RMS
- Current ratings up to 750 Amps
- Available in Aluminium Silicon Bronze, Brass and 316 Stainless Steel
- Acetal dust caps supplied with all connectors (lanyards available on request)
- Optional EXD Rated protective caps available on request
- Optional Earth Bonding
- Termination options include non armoured cables diameters from 3.5mm to 32.2mm and armoured cables from 8.4mm to 39.9mm using standard CMP glands
- Optional approved Polyurethane overmoulding for full IP68 water submersion



HXD: (Connector)

## EExd and EExde Explosion Proof Connectors

### Underwater Mateable HXD (Hydro Bond EExd / EExde)

#### Benefits

- Make and Break connections topside (zone 1) then deploy subsea (2,440 MSW) with same connector
- Easy to use
- Fast Delivery lead times
- Wide variety of pin configurations allows cost effective system design
- Wide variety of metal options allows for best corrosion resistant design

#### Approvals

- BS 5501: Part 1: 1977 (EN 50 014 amendments A1 to A5)
- BS 5501: Part 5: 1977 (EN 50 018 amendments A1 to A3)
- CENELEC Certification Code Eexd IIB T6
- BS EN 60529: 1992 Ingress Protection
- US Coastguard approval

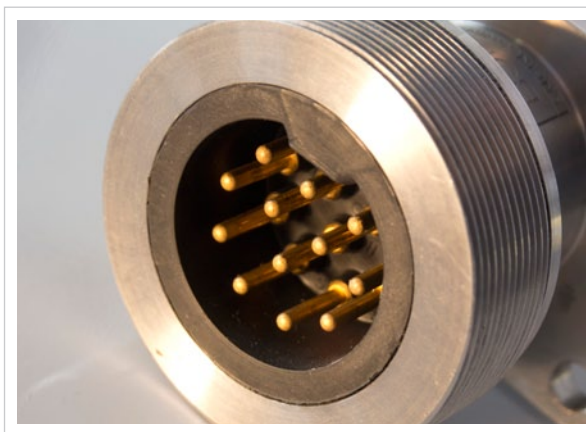

HXD: (Connector)

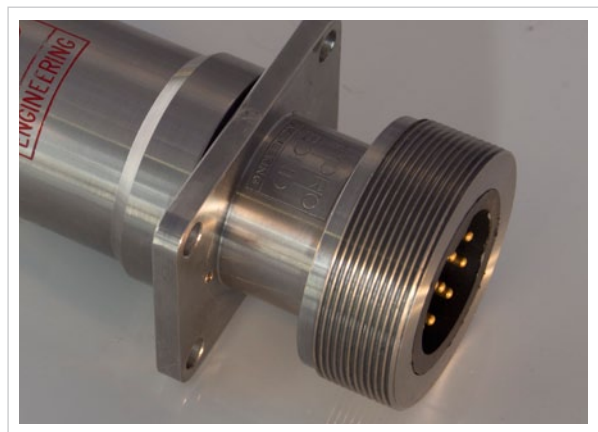

HXD: (Connector)

#### Specifications

The following pages feature a range of HXD (Hydro Bond EExd / EExde) Underwater Mateable Explosion Proof Connectors that have been designed, manufactured and field tested. The following charts feature a range of pin (face view) configurations, together with electrical, environmental and standard material specifications.

# EExd and EExde Explosion Proof Connectors

## Underwater Mateable HXD (Hydro Bond EExd / EExde) : Shell Size 5 / Connector Details

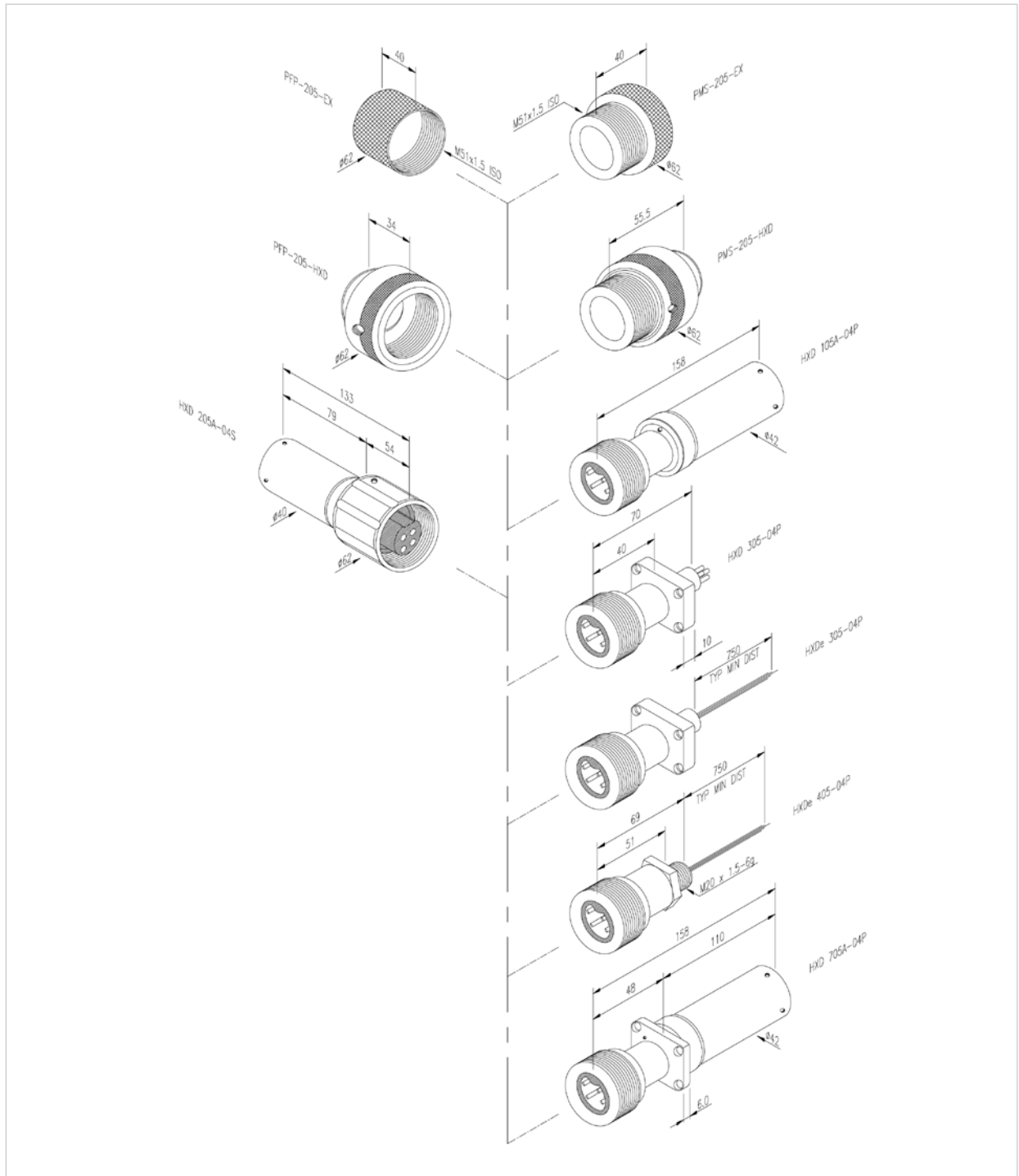

# EExd and EExde Explosion Proof Connectors

## Underwater Mateable HXD (Hydro Bond EExd / EExde) : Shell Size 5 / Mounting Details

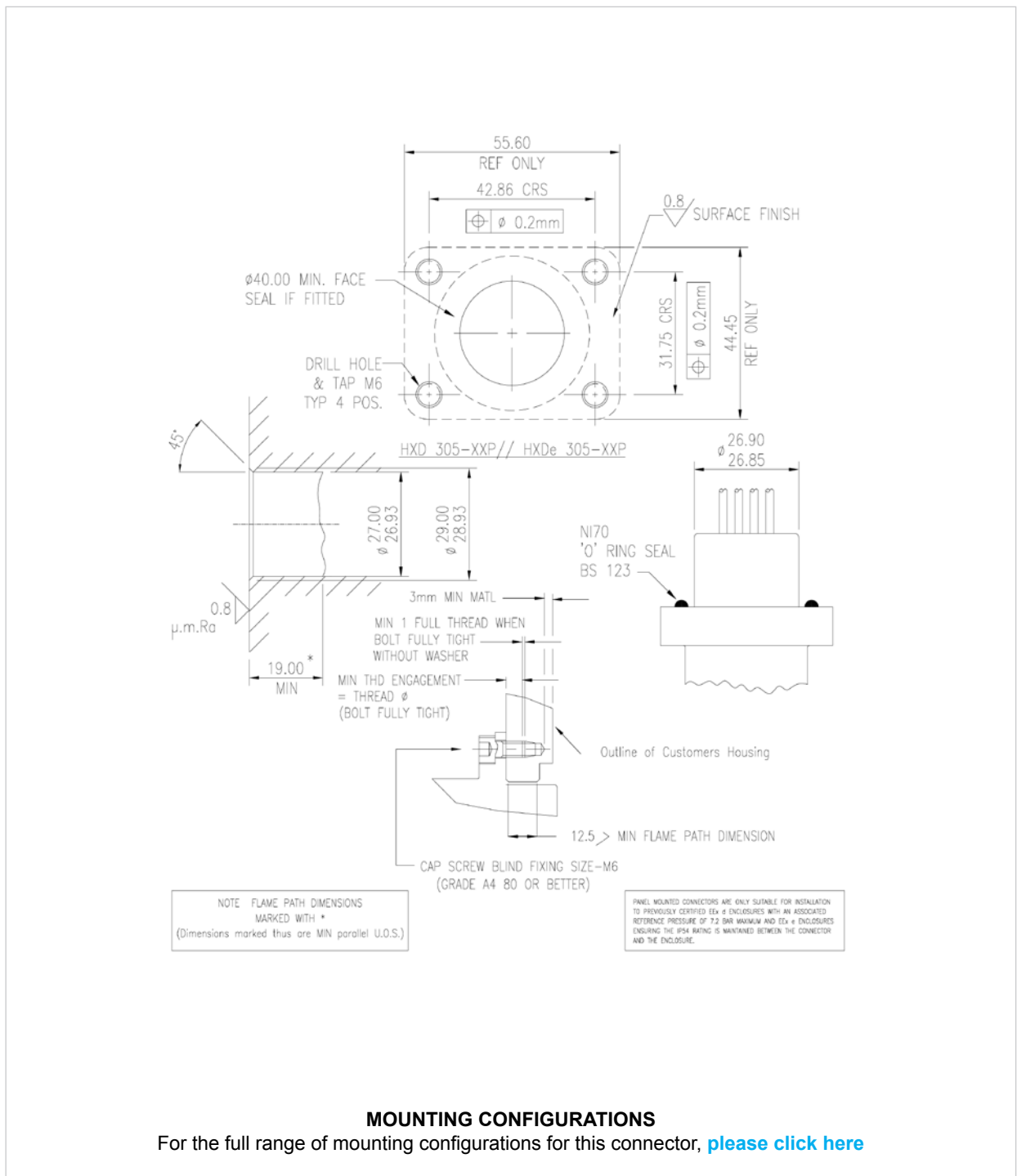

### MOUNTING CONFIGURATIONS

For the full range of mounting configurations for this connector, [please click here](#)

# EExd and EExde Explosion Proof Connectors

## Underwater Mateable HXD (Hydro Bond EExd / EExde): Specifications

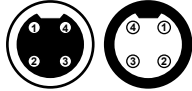
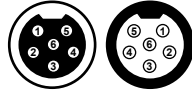
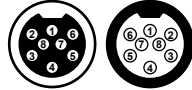
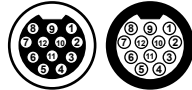
Electrical and Environmental	Standard Material Specification	Face Views
Pin Current Rating: 15 Amps Pin Voltage Rating: 2,000 V rms Gland Size: M16, M20(S) Contact to Contact IR: >1,000 MOhms @ 1,000 V dc Contact to Body IR: >1,000 MOhms @ 1,000 V dc Mated Depth Rating: 2,440 MSW Temperature Rating: -20 ° C to +60 ° C Conductor Tail Size: 18 AWG Solder Bucket Size: 4 x 3.0 mm dia	Body: Aluminium Silicon Bronze Fix Ring: Aluminium Silicon Bronze Back Shell: Aluminium Silicon Bronze Gland: Brass Contact Pins: CZ121/Au Contact Sockets: CZ121/Au Insert Material: Neoprene Conductor Tails: Spec 44 X 0.75 m O – Rings: NI70	Socket Pin  <b>Ref: HXD 05A-04</b>
Pin Current Rating: 8 Amps Pin Voltage Rating: 1,000 V rms Gland Size: M16, M20(S) Contact to Contact IR: >1,000 MOhms @ 1,000 V dc Contact to Body IR: >1,000 MOhms @ 1,000 V dc Mated Depth Rating: 2,440 MSW Temperature Rating: -20 ° C to +60 ° C Conductor Tail Size: 18 AWG Solder Bucket Size: 6 x 2.5 mm dia	Body: Aluminium Silicon Bronze Fix Ring: Aluminium Silicon Bronze Back Shell: Aluminium Silicon Bronze Gland: Brass Contact Pins: CZ121/Au Contact Sockets: CZ121/Au Insert Material: Neoprene Conductor Tails: Spec 44 X 0.75 m O – Rings: NI70	Socket Pin  <b>Ref: HXD 05A-06</b>
Pin Current Rating: 6 Amps Pin Voltage Rating: 1,000 V rms Gland Size: M16, M20(S) Contact to Contact IR: >1,000 MOhms @ 1,000 V dc Contact to Body IR: >1,000 MOhms @ 1,000 V dc Mated Depth Rating: 2,440 MSW Temperature Rating: -20 ° C to +60 ° C Conductor Tail Size: 18 AWG Solder Bucket Size: 8 x 2.5 mm dia	Body: Aluminium Silicon Bronze Fix Ring: Aluminium Silicon Bronze Back Shell: Aluminium Silicon Bronze Gland: Brass Contact Pins: CZ121/Au Contact Sockets: CZ121/Au Insert Material: Neoprene Conductor Tails: Spec 44 X 0.75 m O – Rings: NI70	Socket Pin  <b>Ref: HXD 05A-08</b>
Pin Current Rating: 5 Amps Pin Voltage Rating: 1,000 V rms Gland Size: M16, M20(S) Contact to Contact IR: >1,000 MOhms @ 1,000 V dc Contact to Body IR: >1,000 MOhms @ 1,000 V dc Mated Depth Rating: 2,440 MSW Temperature Rating: -20 ° C to +60 ° C Conductor Tail Size: 18 AWG Solder Bucket Size: 12 x 2.5 mm dia	Body: Aluminium Silicon Bronze Fix Ring: Aluminium Silicon Bronze Back Shell: Aluminium Silicon Bronze Gland: Brass Contact Pins: CZ121/Au Contact Sockets: CZ121/Au Insert Material: Neoprene Conductor Tails: Spec 44 X 0.75 m O – Rings: NI70	Socket Pin  <b>Ref: HXD 05A-12</b>

### Custom Product Design

Not found what you are looking for ?

Our in house engineers design, develop, manufacture and test new products to customer specifications.



# EExd and EExde Explosion Proof Connectors

## Underwater Mateable

## HXD (Hydro Bond EExd / EExde) : Shell Size 6 / Connector Details

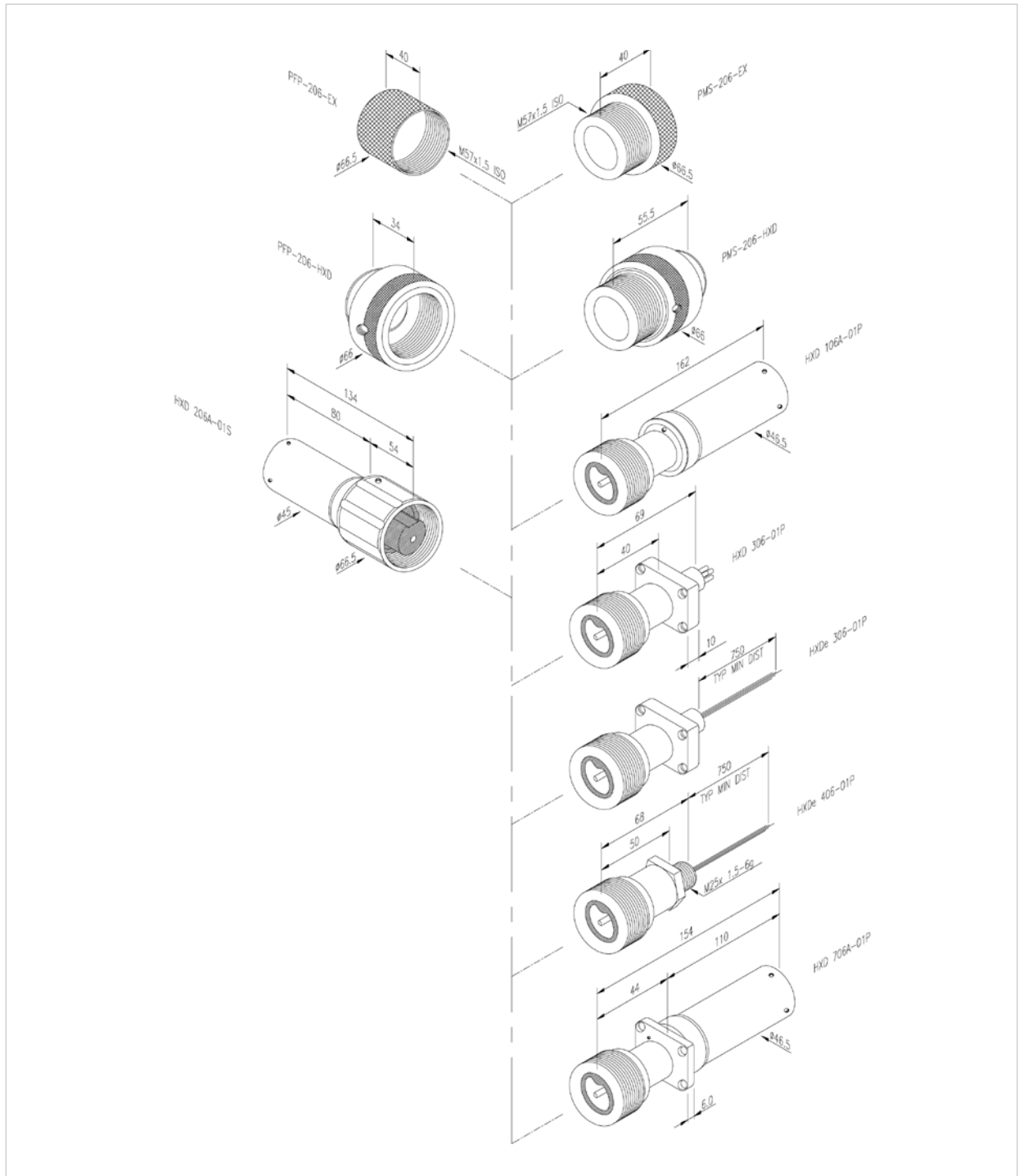

# EExd and EExde Explosion Proof Connectors

## Underwater Mateable

## HXD (Hydro Bond EExd / EExde) : Shell Size 6 / Mounting Details

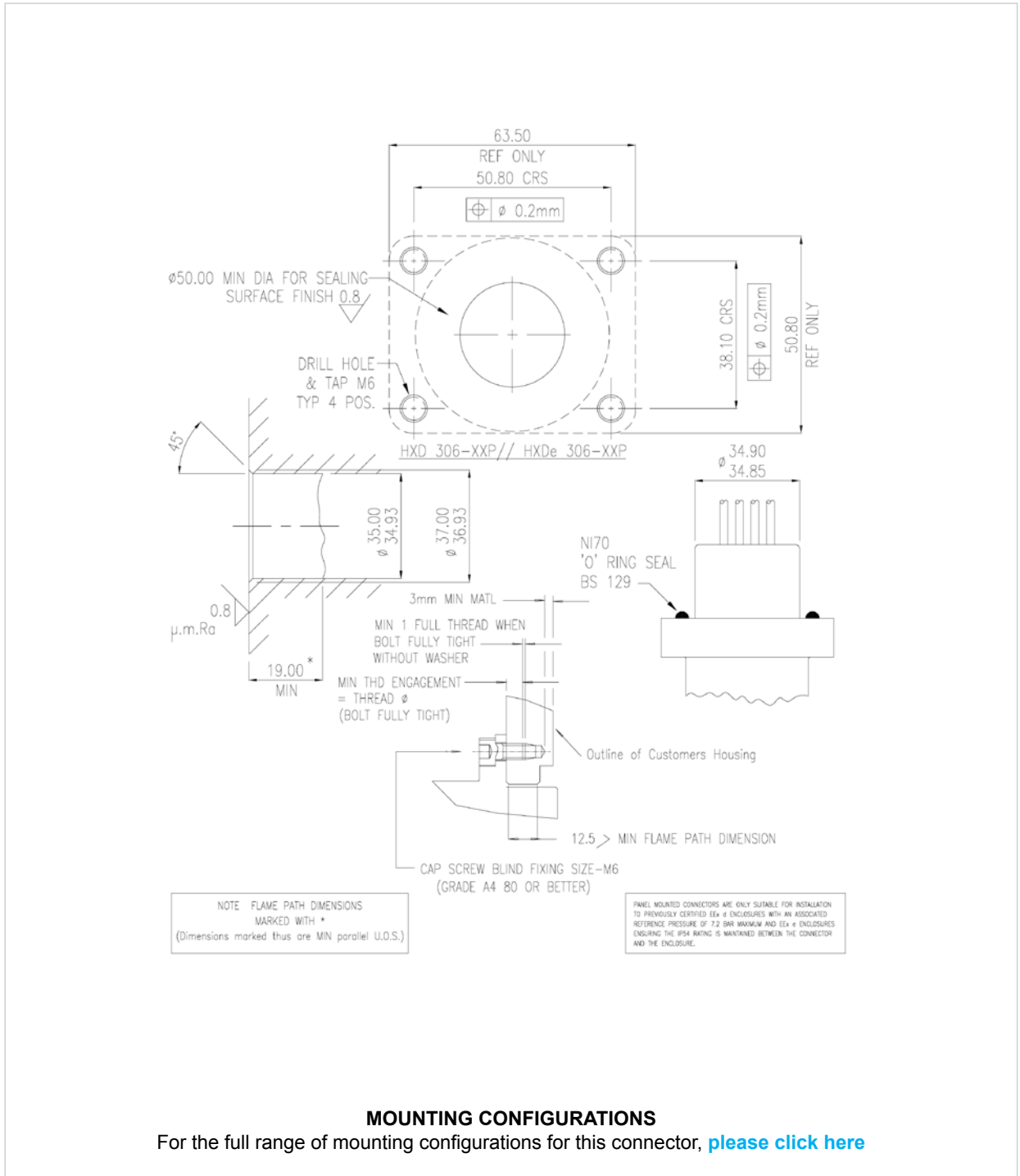



# EExd and EExde Explosion Proof Connectors

## Underwater Mateable HXD (Hydro Bond EExd / EExde): Specifications

Electrical and Environmental	Standard Material Specification	Face Views
Pin Current Rating: <b>40 Amps</b> Pin Voltage Rating: <b>6,000 V rms</b> Gland Size: <b>M16, M20(S)</b> Contact to Contact IR: <b>&gt;1,000 MOhms @ 1,000 V dc</b> Contact to Body IR: <b>&gt;1,000 MOhms @ 1,000 V dc</b> Mated Depth Rating: <b>2,440 MSW</b> Temperature Rating: <b>-20 ° C to +60 ° C</b> Conductor Tail Size: <b>6.0 sq mm</b> Solder Bucket Size: <b>1 x 5.5 mm dia</b>	Body: <b>Aluminium Silicon Bronze</b> Fix Ring: <b>Aluminium Silicon Bronze</b> Back Shell: <b>Aluminium Silicon Bronze</b> Gland: <b>Brass</b> Contact Pins: <b>CZ121/Au</b> Contact Sockets: <b>CZ121/Au</b> Insert Material: <b>Neoprene</b> Conductor Tails: <b>Spec 44 X 0.75 m</b> O – Rings: <b>NI70</b>	Socket      Pin  <b>Ref: HXD 06A-01</b>
Pin Current Rating: <b>5 Amps</b> Pin Voltage Rating: <b>1,000 V rms</b> Gland Size: <b>M16, M20(S)</b> Contact to Contact IR: <b>&gt;1,000 MOhms @ 1,000 V dc</b> Contact to Body IR: <b>&gt;1,000 MOhms @ 1,000 V dc</b> Mated Depth Rating: <b>2,440 MSW</b> Temperature Rating: <b>-20 ° C to +60 ° C</b> Conductor Tail Size: <b>18 AWG</b> Solder Bucket Size: <b>10 x 2.5 mm dia</b>	Body: <b>Aluminium Silicon Bronze</b> Fix Ring: <b>Aluminium Silicon Bronze</b> Back Shell: <b>Aluminium Silicon Bronze</b> Gland: <b>Brass</b> Contact Pins: <b>CZ121/Au</b> Contact Sockets: <b>CZ121/Au</b> Insert Material: <b>Neoprene</b> Conductor Tails: <b>Spec 44 X 0.75 m</b> O – Rings: <b>NI70</b>	Socket      Pin  <b>Ref: HXD 06A-10</b>
Pin Current Rating: <b>5 Amps</b> Pin Voltage Rating: <b>1,000 V rms</b> Gland Size: <b>M16, M20</b> Contact to Contact IR: <b>&gt;1,000 MOhms @ 1,000 V dc</b> Contact to Body IR: <b>&gt;1,000 MOhms @ 1,000 V dc</b> Mated Depth Rating: <b>2,440 MSW</b> Temperature Rating: <b>-20 ° C to +60 ° C</b> Conductor Tail Size: <b>18 AWG</b> Solder Bucket Size: <b>12 x 2.5 mm dia</b>	Body: <b>Aluminium Silicon Bronze</b> Fix Ring: <b>Aluminium Silicon Bronze</b> Back Shell: <b>Aluminium Silicon Bronze</b> Gland: <b>Brass</b> Contact Pins: <b>CZ121/Au</b> Contact Sockets: <b>CZ121/Au</b> Insert Material: <b>Neoprene</b> Conductor Tails: <b>Spec 44 X 0.75 m</b> O – Rings: <b>NI70</b>	Socket      Pin  <b>Ref: HXD 06A-12</b>
Pin Current Rating: <b>5 Amps</b> Pin Voltage Rating: <b>1,000 V rms</b> Gland Size: <b>M16, M20</b> Contact to Contact IR: <b>&gt;1,000 MOhms @ 1,000 V dc</b> Contact to Body IR: <b>&gt;1,000 MOhms @ 1,000 V dc</b> Mated Depth Rating: <b>2,440 MSW</b> Temperature Rating: <b>-20 ° C to +60 ° C</b> Conductor Tail Size: <b>18 AWG</b> Solder Bucket Size: <b>14 x 2.5 mm dia</b>	Body: <b>Aluminium Silicon Bronze</b> Fix Ring: <b>Aluminium Silicon Bronze</b> Back Shell: <b>Aluminium Silicon Bronze</b> Gland: <b>Brass</b> Contact Pins: <b>CZ121/Au</b> Contact Sockets: <b>CZ121/Au</b> Insert Material: <b>Neoprene</b> Conductor Tails: <b>Spec 44 X 0.75 m</b> O – Rings: <b>NI70</b>	Socket      Pin  <b>Ref: HXD 06A-14</b>

### Custom Product Design

Not found what you are looking for ?

Our in house engineers design, develop, manufacture and test new products to customer specifications.



# EExd and EExde Explosion Proof Connectors

## Underwater Mateable HXD (Hydro Bond EExd / EExde) : Shell Size 8 / Connector Details

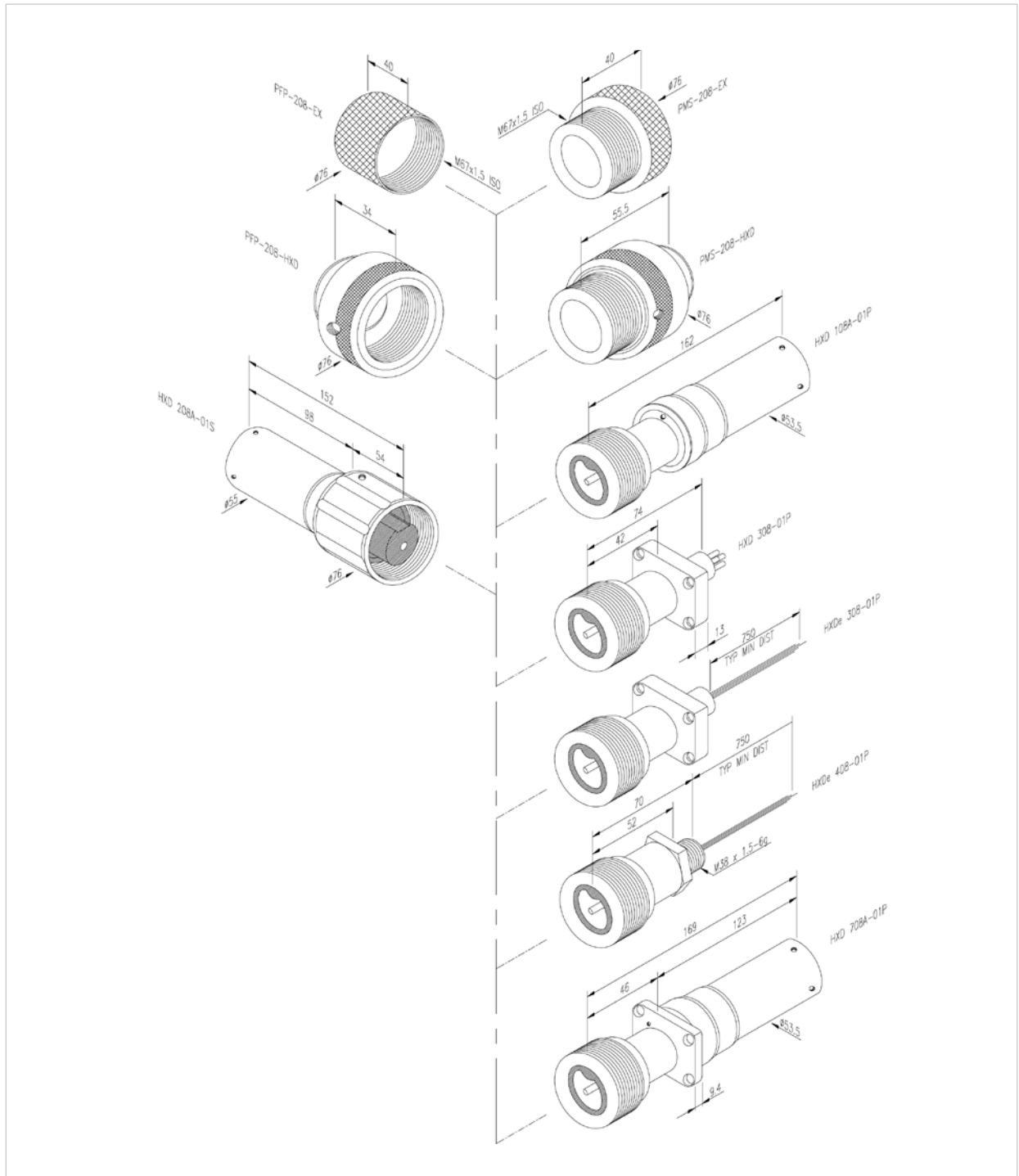

# EExd and EExde Explosion Proof Connectors

## Underwater Mateable HXD (Hydro Bond EExd / EExde) : Shell Size 8 / Mounting Details

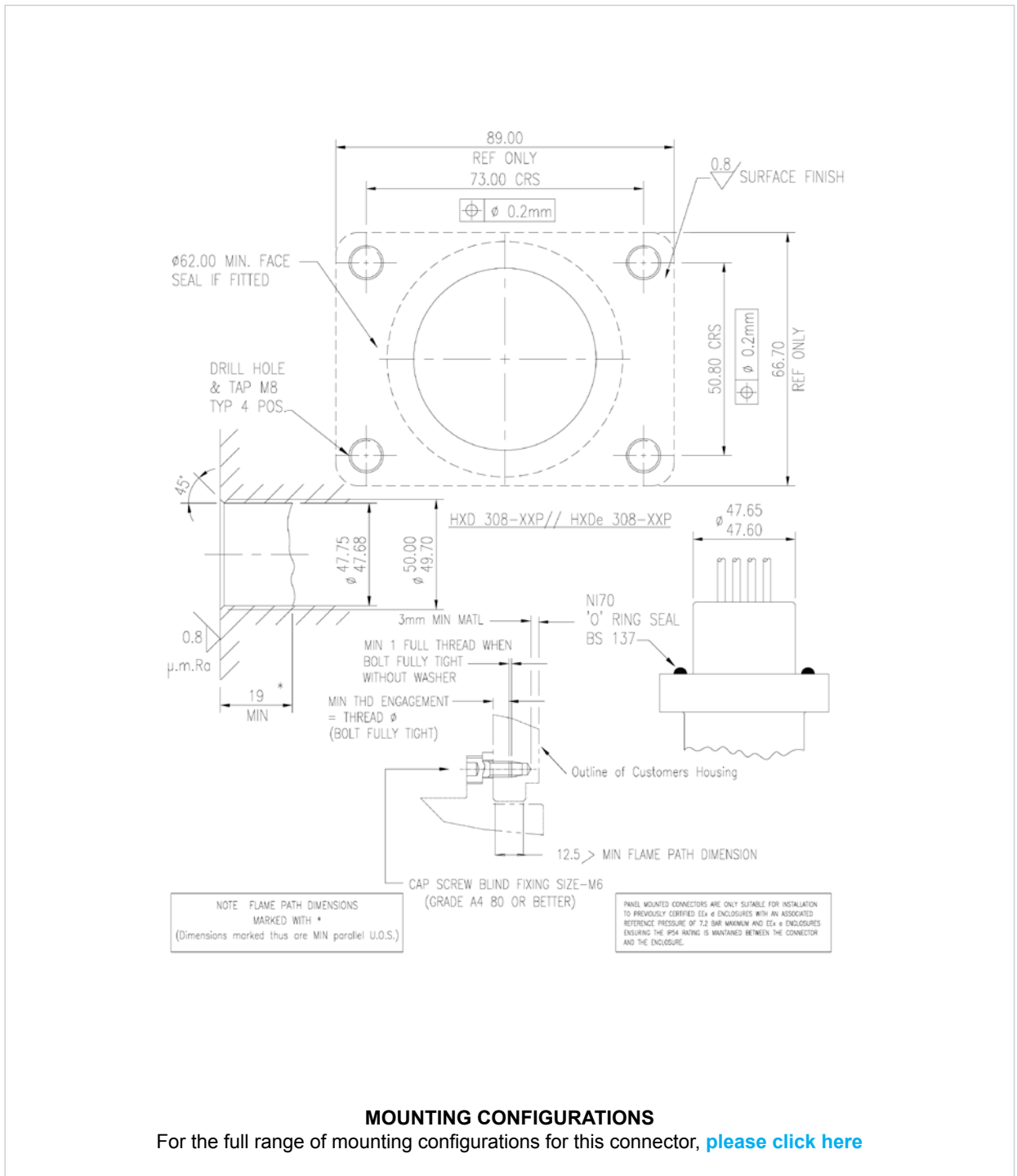

# EExd and EExde Explosion Proof Connectors

## Underwater Mateable HXD (Hydro Bond EExd / EExde): Specifications

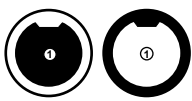
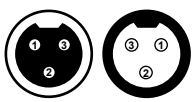
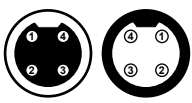
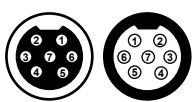
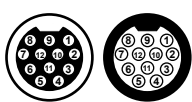
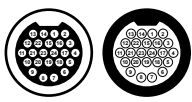
Electrical and Environmental	Standard Material Specification	Face Views
Pin Current Rating: 40 Amps Pin Voltage Rating: 2,000 V rms Gland Size: M16, M20, M25 Contact to Contact IR: >1,000 MOhms @ 1,000 V dc Contact to Body IR: >1,000 MOhms @ 1,000 V dc Mated Depth Rating: 2,440 MSW Temperature Rating: -20 ° C to +60 ° C Conductor Tail Size: 185 sq mm Solder Bucket Size: High Voltage Cable	Body: Aluminium Silicon Bronze Fix Ring: Aluminium Silicon Bronze Back Shell: Aluminium Silicon Bronze Gland: Brass Contact Pins: CZ121/Au Contact Sockets: CZ121/Au Insert Material: Neoprene Conductor Tails: Spec 44 X 0.75 m O – Rings: NI70	Socket Pin  <b>Ref: HXD 08A-01</b>
Pin Current Rating: 50 Amps Pin Voltage Rating: 2,000 V rms Gland Size: M16, M20, M25 Contact to Contact IR: >1,000 MOhms @ 1,000 V dc Contact to Body IR: >1,000 MOhms @ 1,000 V dc Mated Depth Rating: 2,440 MSW Temperature Rating: -20 ° C to +60 ° C Conductor Tail Size: 25 sq mm Solder Bucket Size: 3 x 5.5 mm dia	Body: Aluminium Silicon Bronze Fix Ring: Aluminium Silicon Bronze Back Shell: Aluminium Silicon Bronze Gland: Brass Contact Pins: CZ121/Au Contact Sockets: CZ121/Au Insert Material: Neoprene Conductor Tails: Spec 44 X 0.75 m O – Rings: NI70	Socket Pin  <b>Ref: HXD 08A-03</b>
Pin Current Rating: 36 Amps Pin Voltage Rating: 2,000 V rms Gland Size: M16, M20, M25 Contact to Contact IR: >1,000 MOhms @ 1,000 V dc Contact to Body IR: >1,000 MOhms @ 1,000 V dc Mated Depth Rating: 2,440 MSW(S) Temperature Rating: -20 ° C to +60 ° C Conductor Tail Size: 25 sq mm Solder Bucket Size: 4 x 8.0 mm dia	Body: Aluminium Silicon Bronze Fix Ring: Aluminium Silicon Bronze Back Shell: Aluminium Silicon Bronze Gland: Brass Contact Pins: CZ121/Au Contact Sockets: CZ121/Au Insert Material: Neoprene Conductor Tails: Spec 44 X 0.75 m O – Rings: NI70	Socket Pin  <b>Ref: HXD 08A-04</b>
Pin Current Rating: 2 x 30 Amps, 5 x 14 Amps Pin Voltage Rating: 1,000 V rms Gland Size: M16, M20, M25 Contact to Contact IR: >1,000 MOhms @ 1,000 V dc Contact to Body IR: >1,000 MOhms @ 1,000 V dc Mated Depth Rating: 2,440 MSW(S) Temperature Rating: -20 ° C to +60 ° C Conductor Tail Size: 2 X 10 sq mm, 5 X 14 AWG Solder Bucket Size: 2 x 5.5 mm dia, 5 x 2.5 mm dia	Body: Aluminium Silicon Bronze Fix Ring: Aluminium Silicon Bronze Back Shell: Aluminium Silicon Bronze Gland: Brass Contact Pins: CZ121/Au Contact Sockets: CZ121/Au Insert Material: Neoprene Conductor Tails: Spec 44 X 0.75 m O – Rings: NI70	Socket Pin  <b>Ref: HXD 08A-07</b>
Pin Current Rating: 12 Amps Pin Voltage Rating: 1,000 V rms Gland Size: M16, M20, M25 Contact to Contact IR: >1,000 MOhms @ 1,000 V dc Contact to Body IR: >1,000 MOhms @ 1,000 V dc Mated Depth Rating: 2,440 MSW Temperature Rating: -20 ° C to +60 ° C Conductor Tail Size: 12 AWG Solder Bucket Size: 12 x 3.0 mm dia	Body: Aluminium Silicon Bronze Fix Ring: Aluminium Silicon Bronze Back Shell: Aluminium Silicon Bronze Gland: Brass Contact Pins: CZ121/Au Contact Sockets: CZ121/Au Insert Material: Neoprene Conductor Tails: Spec 44 X 0.75 m O – Rings: NI70	Socket Pin  <b>Ref: HXD 08A-12</b>
Pin Current Rating: 5 Amps Pin Voltage Rating: 1,000 V rms Gland Size: M16, M20, M25 Contact to Contact IR: >1,000 MOhms @ 1,000 V dc Contact to Body IR: >1,000 MOhms @ 1,000 V dc Mated Depth Rating: 2,440 MSW Temperature Rating: -20 ° C to +60 ° C Conductor Tail Size: 18 AWG Solder Bucket Size: 24 x 2.5 mm dia	Body: Aluminium Silicon Bronze Fix Ring: Aluminium Silicon Bronze Back Shell: Aluminium Silicon Bronze Gland: Brass Contact Pins: CZ121/Au Contact Sockets: CZ121/Au Insert Material: Neoprene Conductor Tails: Spec 44 X 0.75 m O – Rings: NI70	Socket Pin  <b>Ref: HXD 08A-24</b>

# EExd and EExde Explosion Proof Connectors

## Underwater Matable HXD (Hydro Bond EExd / EExde): Specifications

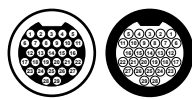
Electrical and Environmental	Standard Material Specification	Face Views
Pin Current Rating: 4 Amps Pin Voltage Rating: 1,000 V rms Gland Size: M16, M20, M25 Contact to Contact IR: >1,000 MOhms @ 1,000 V dc Contact to Body IR: >1,000 MOhms @ 1,000 V dc Mated Depth Rating: 2,440 MSW Temperature Rating: -20 ° C to +60 ° C Conductor Tail Size: 18 AWG Solder Bucket Size: 29 x 2.5 mm dia	Body: Aluminium Silicon Bronze Fix Ring: Aluminium Silicon Bronze Back Shell: Aluminium Silicon Bronze Gland: Brass Contact Pins: CZ121/Au Contact Sockets: CZ121/Au Insert Material: Neoprene Conductor Tails: Spec 44 X 0.75 m O – Rings: NI70	Socket      Pin  Ref: HXD 08A-29

### Custom Product Design

Not found what you are looking for ?

Our in house engineers design, develop, manufacture and test new products to customer specifications.



# EExd and EExde Explosion Proof Connectors

## Underwater Mateable

## HXD (Hydro Bond EExd / EExde) : Shell Size 11 / Connector Details

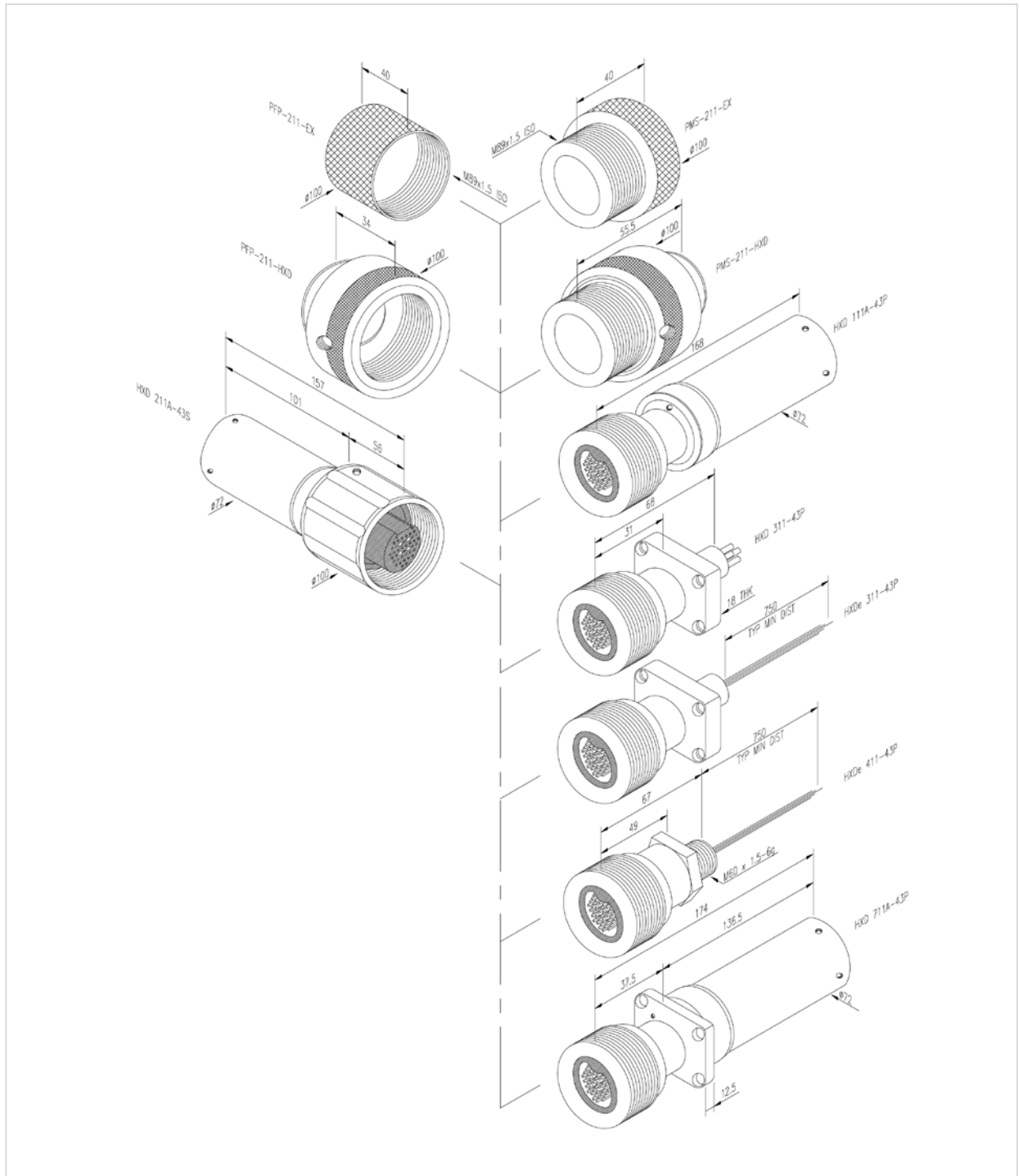

# EExd and EExde Explosion Proof Connectors

## Underwater Mateable HXD (Hydro Bond EExd / EExde) : Shell Size 11 / Mounting Details

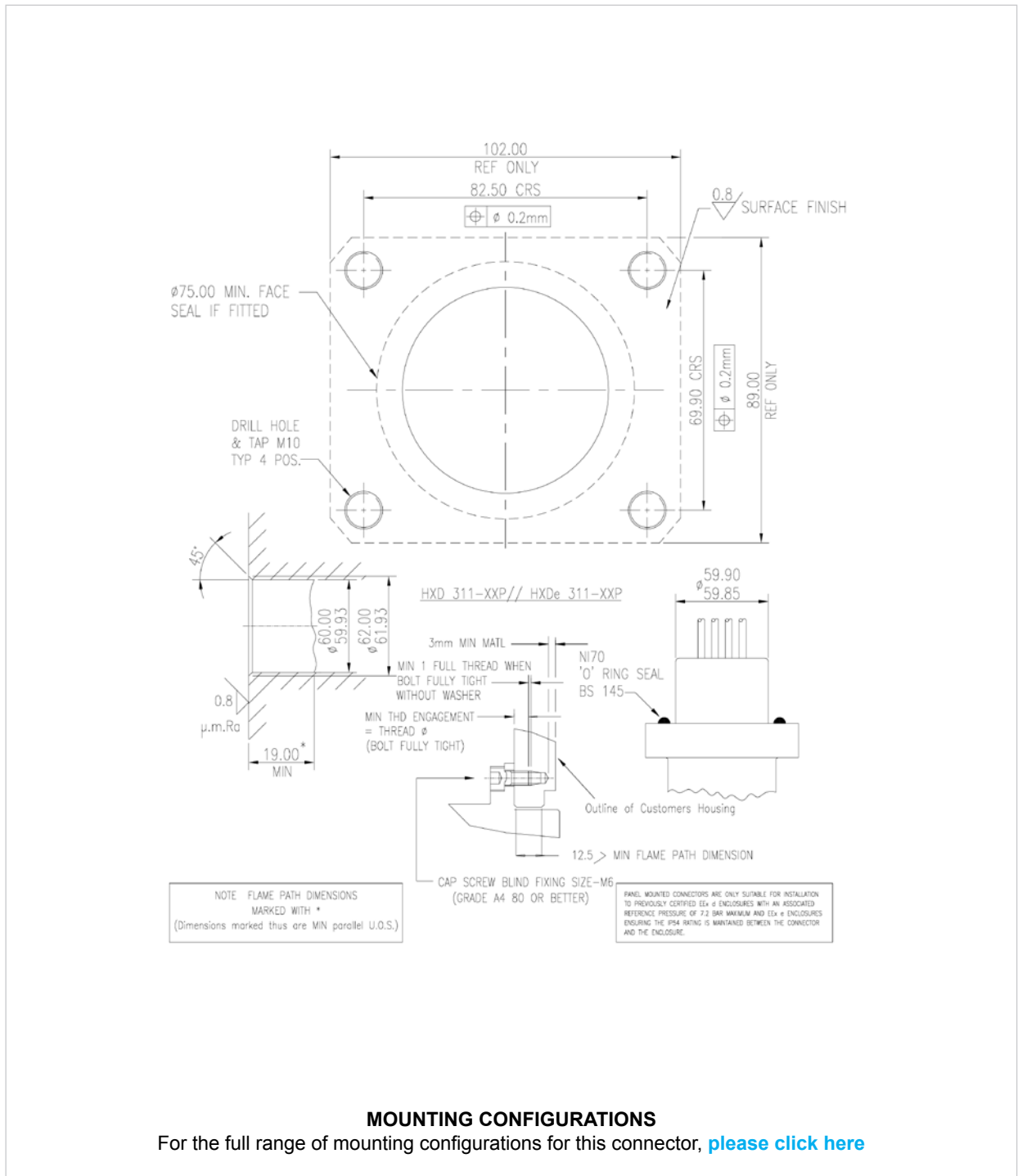

# EExd and EExde Explosion Proof Connectors

## Underwater Mateable HXD (Hydro Bond EExd / EExde): Specifications

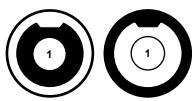
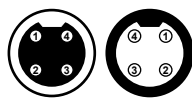
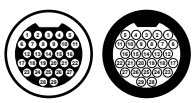
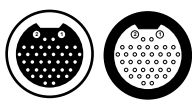
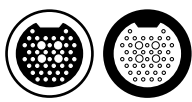
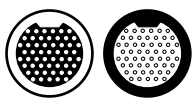
Electrical and Environmental	Standard Material Specification	Face Views
Pin Current Rating: 750 Amps Pin Voltage Rating: 2,000 V rms Gland Size: M16, M20, M25, M32, M40 Contact to Contact IR: >1,000 MOhms @ 1,000 V dc Contact to Body IR: >1,000 MOhms @ 1,000 V dc Mated Depth Rating: 2,440 MSW Temperature Rating: -20 ° C to +60 ° C Conductor Tail Size: 300 sq mm Solder Bucket Size: 1 x 27 mm dia	Body: Aluminium Silicon Bronze Fix Ring: Aluminium Silicon Bronze Back Shell: Aluminium Silicon Bronze Gland: Brass Contact Pins: CZ121/Au Contact Sockets: CZ121/Au Insert Material: Neoprene Conductor Tails: Spec 44 X 0.75 m O – Rings: NI70	Socket Pin  <b>Ref: HXD 11A-01</b>
Pin Current Rating: 150 Amps Pin Voltage Rating: 2,000 V rms Gland Size: M16, M20, M25, M32, M40 Contact to Contact IR: >1,000 MOhms @ 1,000 V dc Contact to Body IR: >1,000 MOhms @ 1,000 V dc Mated Depth Rating: 2,440 MSW Temperature Rating: -20 ° C to +60 ° C Conductor Tail Size: 35 sq mm Solder Bucket Size: 4 x 5.75 mm dia	Body: Aluminium Silicon Bronze Fix Ring: Aluminium Silicon Bronze Back Shell: Aluminium Silicon Bronze Gland: Brass Contact Pins: CZ121/Au Contact Sockets: CZ121/Au Insert Material: Neoprene Conductor Tails: Radox 125, 0.75 m O – Rings: NI70	Socket Pin  <b>Ref: HXD 11A-04</b>
Pin Current Rating: 4 Amps Pin Voltage Rating: 1,000 V rms Gland Size: M16, M20, M25, M32, M40 Contact to Contact IR: >1,000 MOhms @ 1,000 V dc Contact to Body IR: >1,000 MOhms @ 1,000 V dc Mated Depth Rating: 2,440 MSW Temperature Rating: -20 ° C to +60 ° C Conductor Tail Size: 18 AWG Solder Bucket Size: 37 x 2.5 mm dia	Body: Aluminium Silicon Bronze Fix Ring: Aluminium Silicon Bronze Back Shell: Aluminium Silicon Bronze Gland: Brass Contact Pins: CZ121/Au Contact Sockets: CZ121/Au Insert Material: Neoprene Conductor Tails: Spec 44 X 0.75 m O – Rings: NI70	Socket Pin  <b>Ref: HXD 11A-37</b>
Pin Current Rating: 2x25 AMPS, 4X15 Amps, 33x18 Amps Pin Voltage Rating: 1,000 V rms Gland Size: M16, M20, M25, M32, M40 Contact to Contact IR: >1,000 MOhms @ 1,000 V dc Contact to Body IR: >1,000 MOhms @ 1,000 V dc Mated Depth Rating: 2,440 MSW Temperature Rating: -20 ° C to +60 ° C Conductor Tail Size: 2x25 sqmm, 4X14 AWG, 33x18 AWG Solder Bucket Size: 2x8.0mm dia, 37x2.5 mm dia	Body: Aluminium Silicon Bronze Fix Ring: Aluminium Silicon Bronze Back Shell: Aluminium Silicon Bronze Gland: Brass Contact Sockets/Pins: CZ121/Au Insert Material: Neoprene Conductor Tails: 2xPolyrad x 0.75m, 37xSpec 44x0.75m O – Rings: NI70	Socket Pin  <b>Ref: HXD 11A-39</b>
Pin Current Rating: 4x25 AMPS, 39x2 Amps Pin Voltage Rating: 1,000 V rms Gland Size: M16, M20, M25, M32, M40 Contact to Contact IR: >1,000 MOhms @ 1,000 V dc Contact to Body IR: >1,000 MOhms @ 1,000 V dc Mated Depth Rating: 2,440 MSW Temperature Rating: -20 ° C to +60 ° C Conductor Tail Size: 4X10 AWG, 39x18 AWG Solder Bucket Size: 4x3.0mm dia, 39x2.0 mm dia	Body: Aluminium Silicon Bronze Fix Ring: Aluminium Silicon Bronze Back Shell: Aluminium Silicon Bronze Gland: Brass Contact Pins: CZ121/Au Contact Sockets: CZ121/Au Insert Material: Neoprene Conductor Tails: Spec 44 X 0.75 m O – Rings: NI70	Socket Pin  <b>Ref: HXD 11A-43</b>
Pin Current Rating: 3 Amps Pin Voltage Rating: 1,000 V rms Gland Size: M16, M20, M25, M32, M40 Contact to Contact IR: >1,000 MOhms @ 1,000 V dc Contact to Body IR: >1,000 MOhms @ 1,000 V dc Mated Depth Rating: 2,440 MSW Temperature Rating: -20 ° C to +60 ° C Conductor Tail Size: 18 AWG Solder Bucket Size: 54 x 2.5 mm dia	Body: Aluminium Silicon Bronze Fix Ring: Aluminium Silicon Bronze Back Shell: Aluminium Silicon Bronze Gland: Brass Contact Pins: CZ121/Au Contact Sockets: CZ121/Au Insert Material: Neoprene Conductor Tails: Spec 44 X 0.75 m O – Rings: NI70	Socket Pin  <b>Ref: HXD 11A-54</b>



# EExd and EExde Explosion Proof Connectors

## Underwater Matable HXD (Hydro Bond EExd / EExde)

Electrical and Environmental	Standard Material Specification	Face Views
Pin Current Rating: 2 Amps Pin Voltage Rating: 1,000 V rms Gland Size: M16, M20, M25, M32, M40 Contact to Contact IR: >1,000 MOhms @ 1,000 V dc Contact to Body IR: >1,000 MOhms @ 1,000 V dc Mated Depth Rating: 2,440 MSW Temperature Rating: -20 ° C to +60 ° C Conductor Tail Size: 18 AWG Solder Bucket Size: 70 x 2.5 mm dia	Body: Aluminium Silicon Bronze Fix Ring: Aluminium Silicon Bronze Back Shell: Aluminium Silicon Bronze Gland: Brass Contact Pins: CZ121/Au Contact Sockets: CZ121/Au Insert Material: Neoprene Conductor Tails: Spec 44 X 0.75 m O – Rings: NI70	Socket      Pin  Ref: HXD 11A-70

### Custom Product Design

Not found what you are looking for ?

Our in house engineers design, develop, manufacture and test new products to customer specifications.

